



Partlist
15" Plus Colour Changers
(known as RCC 500)

Partlist
15" Plus Colour Changers
(known as RCC500)



Part No. **Name**
PA0555R1 15" PLUS Chassis, black



PA0563 Inner Chassis, 15",8 lite PLUS



PA0561 lower Front 15" Plus



060903 RAINBOW 15" Plus Front DESISTI



060924 RAINBOW 15"Plus Front ARRI 5kW

PA1510-4 Shaft for barndoor wheel 5k, 15"Plus



PA1510-2 Wheel for 5K barndoor Desisti/Strand



PA1510-3 Wheel for 5K barndoor Arri



Partlist
15" Plus Colour Changers
 (known as RCC500)

<u>Part No.</u>	<u>Name</u>	
RCC505	RAINBOW 15" Universal Adapterplate incl. Hookwings (PB0515)	
PB0515	Hook Wings kit for 15" Uniadaptor RCC505	
PB0551:3	Red (left) spindle, 15"Plus & 2K/5K	
PB0554	Blue (right) spindle 15"Plus and 2K/5K	
	<u>Caution: both spindles will be delivered without "roll support pins and springs" ! They have to be ordered seperately:</u>	
PB559	Roll support pin "new", with O-rings	
PA0472	Spring for support pin 1,1x8.5innerx22mm	
PA0585	Brass eng.ment ring, F/M for shaft Ø4	
PA0589	Tension Shaft 4mm, 8-Lite and 15"Plus	
PA0593	Tension Knob, gold for 8L & 15"Plus	
PA0583	Pulley, XL29 left 15" Plus	
PA0588	Roll shaft 6mm for 8-Lite and 15"Plus	
PA0592	Zero Positioning Knob black 8L & 15"Plus	
PA0596	Zero Positioning spring 15"/8-Lite Plus	
PC3002	Ball bearing Ø8mm shaft with flange	

Partlist
15" Plus Colour Changers
 (known as RCC500)

Part No. **Name**
 PA0587 Roll shaft 8mm for 8-Lite and 15"Plus



PA0581 Pulley, T2.5 Z=45 for 15" Plus



PA0569 Worm gear, Z=30m=0,5(Øappr15)



Part No. **Name**
 PA0580 Worm for shaft Ø8, m=0,5



PC2557 Belt, Timing, XL/408-6, 15" & 8lite Plus & Pro



PC2016 Belt, timing, T2,5/200-4



PD2571 Fan. Linear 24V, 60x60x380 with MOLEX 2P



PB0599 Electronic box compl. 15"+8Lite Plus
 incl. all PCB's and cables











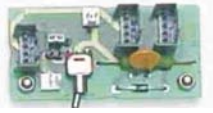

PA0564 Mounting chassis for electronic, 15" Plus



PN1168:5BC DMX PCB, "Plus card", coated,
 with "Mode" and "Frame" HEX rotary switches

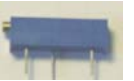

Partlist
15" Plus Colour Changers
 (known as RCC500)

<u>Part No.</u>	<u>Name</u>	
PN39:3C5	Analogue PCB, Version 3 C / 500, 2 – 16 colours	
PN558:1	FAN PCB, Vers.1 for 15" range scrollers	
PN44	LED PCB, Version 2b, three LED's	
PK1008	Cable 5 pole for LEDpcb Z=Link,l=130mm	
PK1009	Cable 4 pole Z=Link,l=60mm	
PK1012	Cable 4 pole Z=Link,l=180mm	
PK1999	Cable, FAN Link f. 15" & 8Lite Plus	
PB1460:A15/24	Motor Airpax 24V, T2.5/15 pulley & cable	
PR6556-1	Potentiometer, feedback, 10 turn, hybrid, 5K, type = 8146	
PR539-2	Rangetrimmer, 10K, with collar <u>Or (please check which part is used in your model)</u>	
PR539-4	Rangetrimmer, 10K, without collar <u>Or (please check which part is used in your model)</u>	
PI239-5	Motor drive circuit, L292	
PE1200	3pole socket for soldering on PCB, grey plastic, for use on Analogue PCB	

Partlist
15" Plus Colour Changers
 (known as RCC500)

<u>Part No.</u>	<u>Name</u>	
PE1212	3pole plug for use on flat cables, grey plastic	
PE1201	4pole socket for soldering on PCB, grey plastic	
PE1211	4pole plug for use on flat cables, grey plastic	
PE1205	5pole socket, 90° for soldering on PCB, grey plastic	
PE1213	5pole plug for use on flat cables, grey plastic	
PE1100	10way connector, female, white plastic for used on Plus card	
PE1105	10way connector, male, for use on Analogue PCB	
PE739-1	Analogue/DMX switch, right angle, for use on Analogue PCB	
PE768-1	DMX BCD rotary switch (0 – 9)	
PE768-3	Mode, Frame HEX rotary switch (0 – F) used on Plus cards	
PD339-7	Relay, Analogue PCB, motorbrake, S904	
PD3001	Relay, Analogue PCB, S902	
PF1002	Screw, M3 x 6 mm, black	
PF1021	Screw, M4 x 8 mm	
PF1081	Grub screw, M3 x 3 mm	
PF1082	Grub screw, M3 x 5 mm	
PF3030	Washer, YT3,2 mm, black	
PF3031	Washer, YT4,3 mm, black	

Partlist
15" Plus Colour Changers
 (known as RCC500)

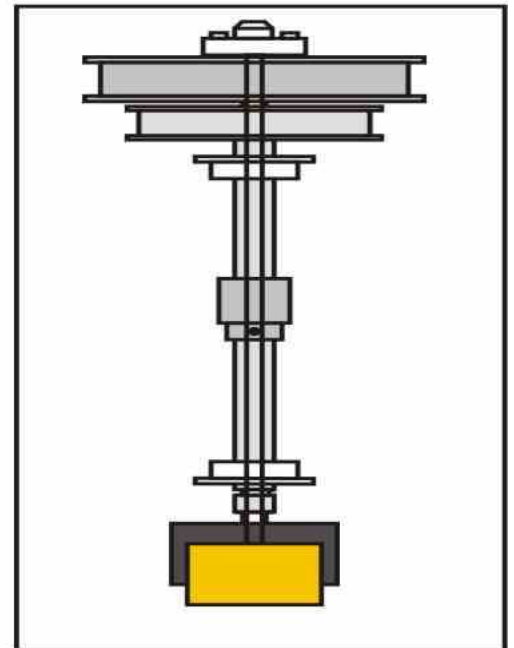
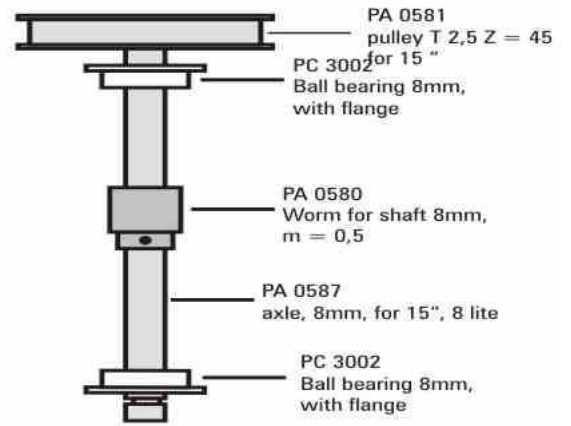
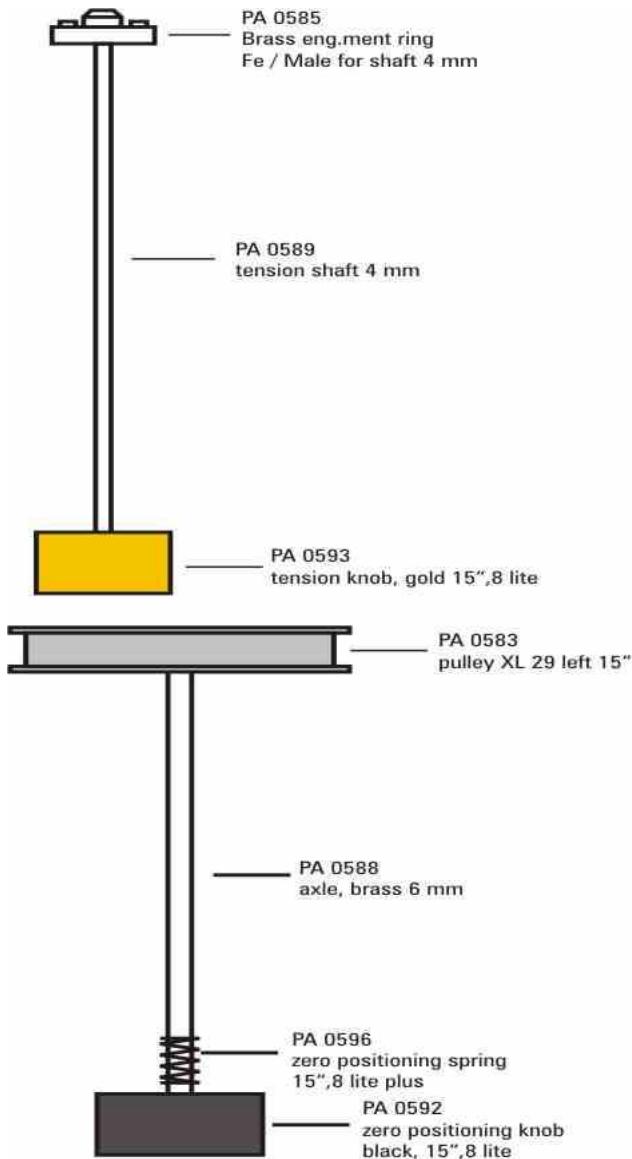



Worldwide Distribution:
Rainbow Colour Changers GmbH
An der Talle 26-28
D-33102 Paderborn
Germany

Tel.: +49 (0) 52 51/14 092-28
Fax: +49 (0) 52 51/14 092-90

www.rainbow-colour-changers.de
info@rainbow-colour-changers.de

©2007 Rainbow Colour Changers GmbH
Rainbow is a registered trademark of
Rainbow Colour Changers GmbH

German Distribution:
Lightpower GmbH
An der Talle 26-28
D-33102 Paderborn
Germany

Tel.: +49 (0) 52 51/14 32-0
Fax: +49 (0) 52 51/14 32-80

www.lightpower.de
info@lightpower.de

All technical specifications are subject to change without notification. We do not assume liability for any incorrect information in this partlist.